

## 251 Sequoia

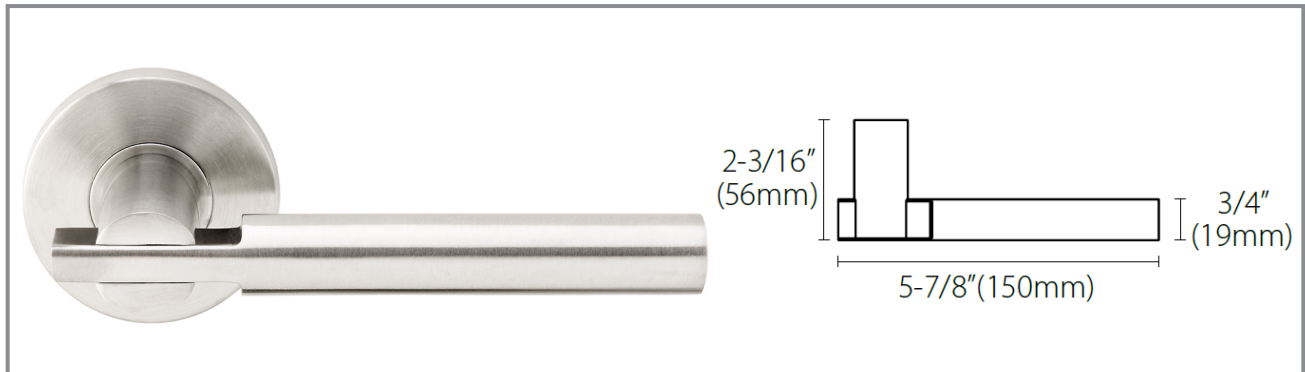

### Material

Stainless Steel Levers and Escutcheons

### Standard Finishes

US32 (629) Bright Polished Stainless Steel  
 US32D (630) Satin Stainless Steel SP -  
 Two-tone Polished and Satin Stainless  
 Steel (US32/US32D)

CeraMax Ceramic Coating:

- Graphite Black (C19G)
- Flat Black (C19)
- Stormy Grey (CGY)
- Dark Bronze (CDB)

### Functions

#### Tubular Latch Set with RA, SE, GT, or GS Rose or SH Plate

Passage, 2-3/8" backset = L461  
 Passage, 2-3/4" backset = L471  
 Privacy, 2-3/8" backset = L462  
 Privacy, 2-3/4" backset = L472  
 Single Dummy Left = DL  
 Single Dummy Right = DR  
 Full Dummy = DL + DR  
 Half Passage/Communicating:

2-3/8" backset = L465  
 2-3/4" backset = L475

#### Tubular Entry Set with Deadbolt and LA, SF or SH Plate

2-3/8" backset = C463  
 2-3/4" backset = C473

Handing required on Single Dummy, Entry, Mortise,  
 Multipoint Functions and Custom sets

### Door Thickness

1-3/8" to 1-3/4" (35mm to 44mm)  
 Thick Door Kits available

### Features

- Concealed fixings
- Spring-assisted chassis
- Same lever design with multiple escutcheons and functions to suit multiple applications
- TL4 Latches - ADA Compliant



### Escutcheon Options



**RA Rose**  
 2-1/2" Diameter  
 (64mm)



**SE Rose**  
 2-3/8" Square  
 (60mm)



**GT Rose**  
 2-1/16" Diameter  
 (53mm)

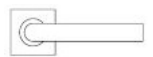

**GS Rose**  
 2-1/16" Square  
 (53mm)

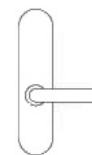

**LA Plate**  
 10-1/2" x 2-1/2"  
 267mm x 63mm

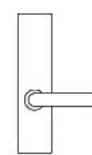

**SF Plate**  
 10-1/2" x 2-1/2"  
 267mm x 63mm

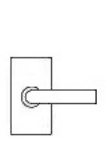

**SH Plate**  
 4-1/2" x 2-3/8"  
 115mm x 60mm

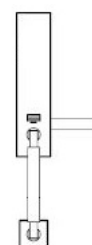

**NY/MH Plate**  
 17-1/8" x 2-1/2"  
 453mm x 63mm

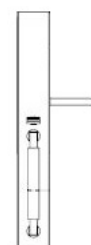

**ME/BW Plate**  
 18-1/8" x 2-1/2"  
 460mm x 63mm

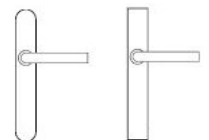

**BP/MU Plate**  
 10-1/2" x 1-5/8"  
 (267mm x 42mm)