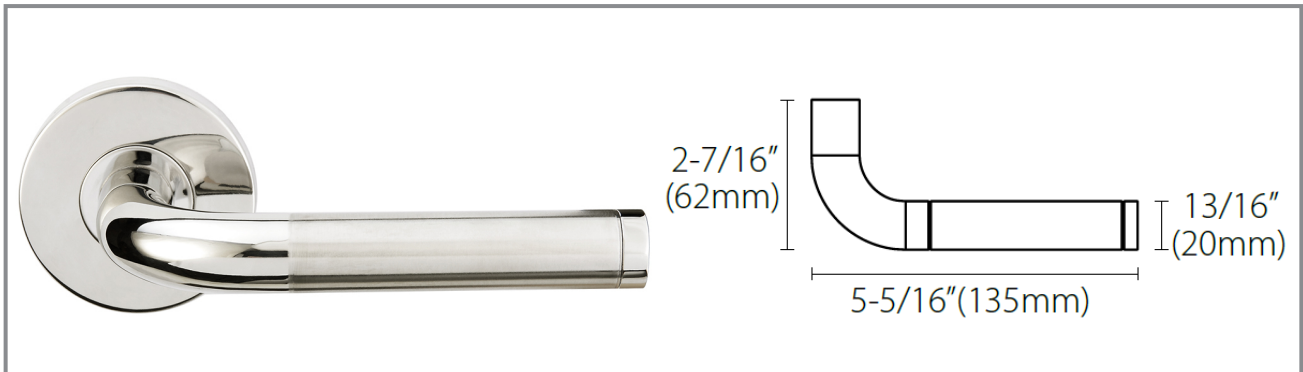

108 Vienna

Material

Stainless Steel Levers and Escutcheons

Door Thickness

 1-3/8" to 1-3/4" (35mm to 44mm)
 Thick Door Kits available

Standard Finishes

 Two-tone Finish:
 US32 (629) Polished Stainless Steel and
 US32D (630) Satin Stainless Steel
 CeraMax Ceramic Coating:

- Graphite Black (C19G)
- Flat Black (C19)
- Stormy Grey (CGY)
- Dark Bronze (CDB)

Features

- Concealed fixings
- Spring-assisted chassis
- Same lever design with multiple escutcheons and functions to suit multiple applications
- TL4 Latches - ADA Compliant

Functions
Tubular Latch Set with RA, SE, GT, or GS Rose or SH Plate

 Passage, 2-3/8" backset = L461
 Passage, 2-3/4" backset = L471
 Privacy, 2-3/8" backset = L462
 Privacy, 2-3/4" backset = L472
 Single Dummy Left= DL
 Single Dummy Right= DR
 Full Dummy= DL + DR
 Half Passage/Communicating:

- 2-3/8" backset= L465
- 2-3/4" backset= L475

Tubular Entry Set with Deadbolt and LA, SF or SH Plate

 2-3/8" backset = C463
 2-3/4" backset = C473

Multipoint Trim with BP/MU Plate

 Key to Lever Distance: 3-5/8" (92mm)
 Passage= MA10
 Patio US Cylinder= MA15
 Entry US Cylinder= MA55
 Patio Euro Cylinder= MA25
 Entry Euro Cylinder= MA35
 Half Passage/Half Dummy= MA20
 Full Dummy= MADP

**Mortise Handleset with NY/MH or ME/BW Plate
 MT Mortise Backset: 2-3/4"**
1-3/4" Door Only
 Entrance= MT720
 Dummy= EDP

Escutcheon Options

RA Rose
 2-1/2" Diameter
 (64mm)

SE Rose
 2-3/8" Square
 (60mm)

GT Rose
 2-1/16" Diameter
 (53mm)

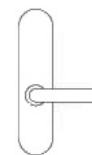
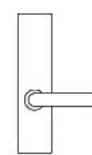
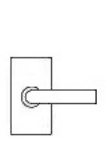
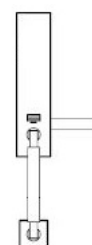
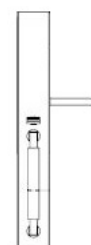
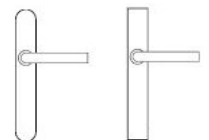
GS Rose
 2-1/16" Square
 (53mm)

LA Plate
 10-1/2" x 2-1/2"
 267mm x 63mm

SF Plate
 10-1/2" x 2-1/2"
 267mm x 63mm

SH Plate
 4-1/2" x 2-3/8"
 115mm x 60mm

NY/MH Plate
 17-1/8" x 2-1/2"
 453mm x 63mm

ME/BW Plate
 18-1/8" x 2-1/2"
 460mm x 63mm

BP/MU Plate
 10-1/2" x 1-5/8"
 (267mm x 42mm)

 Handing required on Single Dummy, Entry, Mortise,
 Multipoint Functions and Custom sets