

107 Stockholm

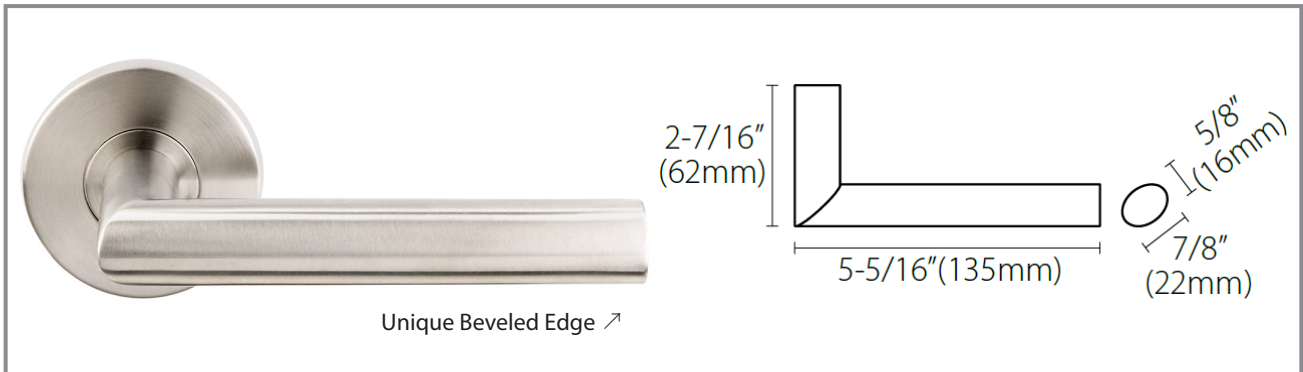

Material

Stainless Steel Levers and Escutcheons

Door Thickness

1-3/8" to 1-3/4" (35mm to 44mm)
Thick Door Kits available

Standard Finishes

US32 (629) Bright Polished Stainless Steel
US32D (630) Satin Stainless Steel
CeraMax Ceramic Coating:
- Graphite Black (C19G)
- Flat Black (C19)
- Stormy Grey (CGY)
- Dark Bronze (CDB)

Features

- Concealed fixings
- Spring-assisted chassis
- Same lever design with multiple escutcheons and functions to suit multiple applications
- TL4 Latches - ADA Compliant



Functions

Tubular Latch Set with RA, SE, GT, or GS Rose or SH Plate

Passage, 2-3/8" backset = L461
Passage, 2-3/4" backset = L471
Privacy, 2-3/8" backset = L462
Privacy, 2-3/4" backset = L472
Single Dummy Left= DL
Single Dummy Right= DR
Full Dummy= DL + DR
Half Passage/Communicating:
2-3/8" backset= L465
2-3/4" backset= L475

Tubular Entry Set with Deadbolt and LA, SF or SH Plate

2-3/8" backset = C463
2-3/4" backset = C473

Multipoint Trim with BP/MU Plate

Key to Lever Distance: 3-5/8" (92mm)
Passage= MA10
Patio US Cylinder= MA15
Entry US Cylinder= MA55
Patio Euro Cylinder= MA25
Entry Euro Cylinder= MA35
Half Passage/Half Dummy= MA20
Full Dummy= MADP

**Mortise Handleset with NY/MH or ME/BW Plate
MT Mortise Backset: 2-3/4"**

1-3/4" Door Only
Entrance= MT720
Dummy= EDP

Escutcheon Options



RA Rose
2-1/2" Diameter
(64mm)



SE Rose
2-3/8" Square
(60mm)



GT Rose
2-1/16" Diameter
(53mm)



GS Rose
2-1/16" Square
(53mm)

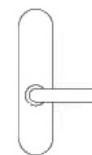

LA Plate
10-1/2" x 2-1/2"
267mm x 63mm

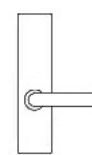

SF Plate
10-1/2" x 2-1/2"
267mm x 63mm

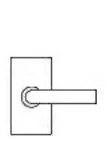

SH Plate
4-1/2" x 2-3/8"
115mm x 60mm

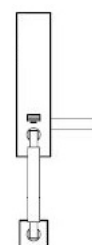

NY/MH Plate
17-1/8" x 2-1/2"
453mm x 63mm

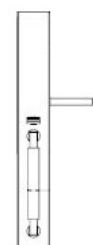

ME/BW Plate
18-1/8" x 2-1/2"
460mm x 63mm

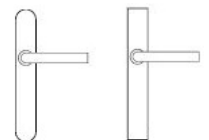

BP/MU Plate
10-1/2" x 1-5/8"
(267mm x 42mm)

Handing required on Single Dummy, Entry, Mortise, Multipoint Functions and Custom sets